



Technical Data

Shaver Socket

Brief product description:

The subtle design will blend with any décor - suitable for domestic or commercial installations.

Features:

- Stylish modern profile
- Covers to conceal fixing screws
- Colour coded terminals for easy installation

Product Images



820

Technical Specifications

Standard(s)	BS EN 61558 BS 4573
ASTA Approval	License Number 1016
Rating	20VA
Output voltages	115/230V
Terminal Capacity	3 x 2.5mm ² 2 x 4mm ²
RoHS Directive	No
WEEE Directive	No
Mounting Box Depth(Min)	47mm
Fixing Centres	120.6mm
Size	146.5mm x 86mm x 48.5mm



Line Diagrams

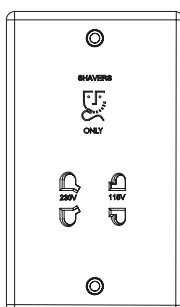

820

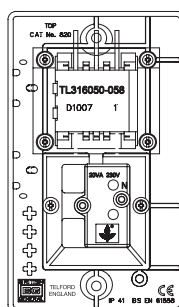
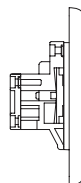

Shaver Socket

Packaging Information

Cat No.	Description	Packaging Type			Pack Quantity			Barcode		
		Product	Inner Box	Outer Box	Each	Inner Box	Outer Box	Individual	Inner Box	Outer Box
820	Shaver Socket 115/230V Dual Voltage	Nexus Poly Bag	Nexus Inner	Nexus Outer	1	5	30	5050765002714	5050765002721	5050765002738

Weights & Dimensions

Cat No.	Description	Dimension (W x L x H) cm			Weight (g)			CBM (m ³)
		Product	Inner Box	Outer Box	Each	Inner Box	Outer Box	Outer Box
820	Shaver Socket 115/230V Dual Voltage	9 x 15.5 x 6	16.5 x 32.5 x 9.5	31 x 35 x 34	670	3500	23500	0.04

Installation Information

Safety Warning

Before use please read carefully and use in accordance with these safety wiring instructions.

Before commencing any electrical work ensure the supply is **switched off at the mains**. Either by switching off the consumer unit or by removing the appropriate fuse.

Wiring should be in accordance with the latest edition of the IEE regulations (BS 7671).

Wire Identification – Twin & Earth Cable

EARTH = Green/Yellow Slewing

NEUTRAL = Black (pre Apr 04) / Blue (after Apr 04)

LIVE = Red (pre Apr 04) / Brown (after Apr 04)



Technical Helpline: 03300 249 279

If in doubt consult a competent electrician.

The ends of the individual conductors should have the insulation removed by approx. 12mm. Any bare earth conductors should be sleeved to within 12mm of the ends. (These details are for general information only and conductor lengths may need to be trimmed in certain installations).

General Installation Instructions

- 1) If using the new product to replace an old one, note the cable connections and wire up new product in the same way as the old one, with Earthing as stated in these instructions.
- 2) Ensure the mounting box (metal or patress) for either flush or surface mounting is the appropriate size for the product.
- 3) Route the cable through the most suitable entry point of the mounting box. If a metal box is used, a protective cable grommet should be used.
- 4) Cables should be prepared so a sufficient conductor length reaches the terminals. Strip the ends of the individual conductors so that an adequate length enters the terminals.
- 5) Carefully arrange the wiring to lie along the edges of the product or box, keeping the central area clear.
- 6) To assist with the correct installation please consult the appropriate wiring diagram on this leaflet.
- 7) When connecting the new accessory ensure that only the bare end of the wire enters the terminal, and no bare wires are visible.

Always tighten the terminal screws securely, but do not overtighten.

An earth connection should always be made between the mounting box earth terminal, and the accessory earth terminal, where fitted. If this earth wire is bare, it is essential that it is sheathed with a length of green/yellow sleeving.

8) Carefully position the accessory into the wall box, ensuring that no wires are trapped between the plate and the wall. Do not overtighten the screws. (Fit screw covers + clip-on)

9) Once work has been completed correctly, replace the fuse for the circuit, switch the power back on, and test.

The product is now ready for use.

* Note - If your installation uses a four lug metal mounting box, remove the top and bottom lugs or bend fully back.

When Installing From New

Shaver Sockets can be installed either by connecting to a ring main with junction box, or from an earthed lighting socket.

1. Select the appropriate size of mounting box (metal or patress) for either flush or surface mounting.
2. Ensure that the mounting box is free of any plaster lumps and projecting screws in the central areas of the box.
3. Always cable of the correct rating.
4. Route the cable through the most suitable entry point of the mounting box. If a metal box is used, ensure that a protective cable grommet is fitted.
5. Carefully arrange the wiring so as to lie along the edges of the product or box, keeping the central area clear.
6. The feed supply should be at least 1.0mm 3 core wire. (2 core with earth).
7. Insert the bare end of the Live wire (Brown or Red) to the terminal marked "L" and tighten securely. Ensure no bare wires are visible.
8. Insert the bare end of the Neutral wire (Blue or Black) to the terminal marked "N" and tighten securely. Ensure no bare wires are visible.
9. Insert the bare end of the Earth wire (Green & Yellow) to the terminal marked "⊕" and tighten securely. Ensure no bare wires are visible. To assist with the correct installation of this product please consult the wiring diagram.
10. The earth connection should always be made to both the mounting box earth terminal, and the shaver socket earth terminal.
11. Carefully position the Shaver Socket into the wall box, ensuring that no wires are trapped between the plate and the wall, and fully secure using the fixing screws provided. Do not overtighten the screws.
12. To prevent moisture from entering the socket, due to the formation of condensation on the walls, it is recommended to fill any gaps between the mounting and the socket with a suitable waterproof sealant.
13. Once you are sure that all work has been completed correctly, replace the fuse for the circuit, switch the power back on, and test. The Shaver Socket is now ready for use.

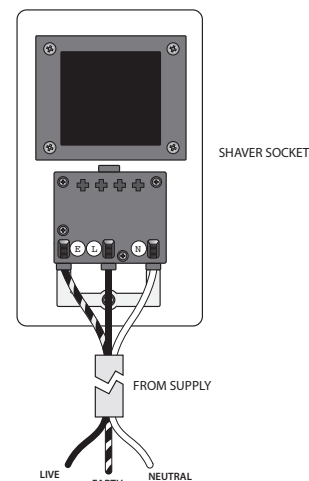



Technical Data

Shaver Socket

Brief product description:

A standard range of white moulded wall accessories offering superb quality and exceptional value.

Features:

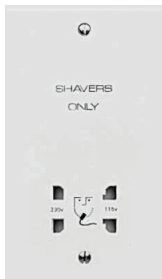

- A standard design - suitable for domestic or commercial installations
- Colour coded terminals for easy installation

Product Images



940

Technical Specifications

Standard(s)	BS EN 61558 BS 4573		
ASTA Approval	License Number 1016		
Rating	20VA		
Output voltages	115/230V		
Terminal Capacity	3 x 2.5mm ² 2 x 4mm ²		
RoHS Directive	No		
WEEE Directive	No		
Mounting Box Depth(Min)	47mm		
Fixing Centres	120.6mm		
Size	146.5mm x 86mm x 48.5mm		

Line Diagrams

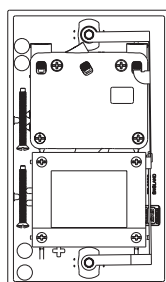
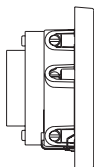
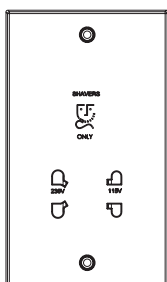

940

Shaver Socket

Packaging Information

Cat No.	Description	Packaging Type			Pack Quantity			Barcode		
		Product	Inner Box	Outer Box	Each	Inner Box	Outer Box	Individual	Inner Box	Outer Box
940	Shaver Socket 115/230V Dual Voltage	Plain Bag	Plain Inner	Plain Outer	1	10	100	/	5021166101092	5021166101085

Weights & Dimensions

Cat No.	Description	Dimension (W x L x H) cm			Weight (g)			CBM (m ³)
		Product	Inner Box	Outer Box	Each	Inner Box	Outer Box	Outer Box
940	Shaver Socket 115/230V Dual Voltage	6 x 9 x 15.5	16.5 x 31.5 x 9.5	17.5 x 59 x 32.5	31	1550	21400	0.03

Installation Information

Safety Warning

Before use please read carefully and use in accordance with these safety wiring instructions.

Before commencing any electrical work ensure the supply is **switched off at the mains**. Either by switching off the consumer unit or by removing the appropriate fuse.

Wiring should be in accordance with the latest edition of the IEE regulations (BS 7671).

Wire Identification – Twin & Earth Cable

EARTH = Green/Yellow Slewing

NEUTRAL = Black (pre Apr 04) / Blue (after Apr 04)

LIVE = Red (pre Apr 04) / Brown (after Apr 04)



Technical Helpline: 03300 249 279
If in doubt consult a competent electrician.

The ends of the individual conductors should have the insulation removed by approx. 12mm. Any bare earth conductors should be sleeved to within 12mm of the ends. (These details are for general information only and conductor lengths may need to be trimmed in certain installations).

General Installation Instructions

- 1) If using the new product to replace an old one, note the cable connections and wire up new product in the same way as the old one, with Earthing as stated in these instructions.
- 2) Ensure the mounting box (metal or patress) for either flush or surface mounting is the appropriate size for the product.
- 3) Route the cable through the most suitable entry point of the mounting box. If a metal box is used, a protective cable grommet should be used.
- 4) Cables should be prepared so a sufficient conductor length reaches the terminals. Strip the ends of the individual conductors so that an adequate length enters the terminals.
- 5) Carefully arrange the wiring to lie along the edges of the product or box, keeping the central area clear.
- 6) To assist with the correct installation please consult the appropriate wiring diagram on this leaflet.
- 7) When connecting the new accessory ensure that only the bare end of the wire enters the terminal, and no bare wires are visible.

Always tighten the terminal screws securely, but do not overtighten.

An earth connection should always be made between the mounting box earth terminal, and the accessory earth terminal, where fitted. If this earth wire is bare, it is essential that it is sheathed with a length of green/yellow sleeving.

- 8) Carefully position the accessory into the wall box, ensuring that no wires are trapped between the plate and the wall. Do not overtighten the screws. (Fit screw covers + clip-on)

- 9) Once work has been completed correctly, replace the fuse for the circuit, switch the power back on, and test.

The product is now ready for use.

* Note - If your installation uses a four lug metal mounting box, remove the top and bottom lugs or bend fully back.

When Installing From New

Shaver Sockets can be installed either by connecting to a ring main with junction box, or from an earthed lighting socket.

1. Select the appropriate size of mounting box (metal or patress) for either flush or surface mounting.
2. Ensure that the mounting box is free of any plaster lumps and projecting screws in the central areas of the box.
3. Always cable of the correct rating.
4. Route the cable through the most suitable entry point of the mounting box. If a metal box is used, ensure that a protective cable grommet is fitted.
5. Carefully arrange the wiring so as to lie along the edges of the product or box, keeping the central area clear.
6. The feed supply should be at least 1.0mm 3 core wire. (2 core with earth).
7. Insert the bare end of the Live wire (Brown or Red) to the terminal marked "L" and tighten securely. Ensure no bare wires are visible.
8. Insert the bare end of the Neutral wire (Blue or Black) to the terminal marked "N" and tighten securely. Ensure no bare wires are visible.
9. Insert the bare end of the Earth wire (Green & Yellow) to the terminal marked "⊕" and tighten securely. Ensure no bare wires are visible.

To assist with the correct installation of this product please consult the wiring diagram.

10. The earth connection should always be made to both the mounting box earth terminal, and the shaver socket earth terminal.
11. Carefully position the Shaver Socket into the wall box, ensuring that no wires are trapped between the plate and the wall, and fully secure using the fixing screws provided. Do not overtighten the screws.
12. To prevent moisture from entering the socket, due to the formation of condensation on the walls, it is recommended to fill any gaps between the mounting and the socket with a suitable waterproof sealant.
13. Once you are sure that all work has been completed correctly, replace the fuse for the circuit, switch the power back on, and test. The Shaver Socket is now ready for use.

