

TECHNICAL DATASHEET

ADRCV1245TD
45W 12V DC CONSTANT VOLTAGE TRIAC DIMMABLE



PRODUCT FEATURES

- Constant Voltage LED Power Supply
- Moulded Polycarbonate Body
- Overload Protection
- Regulated Output
- Thermal Cutout
- SELV Rated
- Triac Dimmable

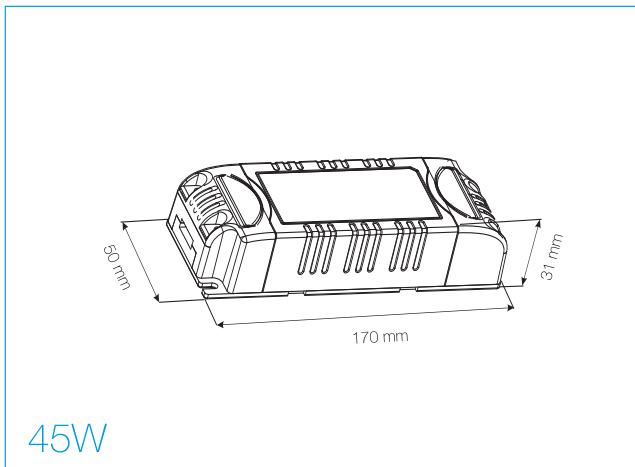

MAINS
DIMMABLE

		ErP Compliant	
	3 Year Guarantee	12V	

PRODUCT CODE	ADRCV1245TD
Operating Voltage	180-240 V AC
Output Voltage	12V DC
Operating Load	30-45W
Output Current (Max.)	3.75A
Temperature	-30~+45°C