

TECHNICAL DATASHEET

ADRCV2460
60W 24V DC CONSTANT VOLTAGE LED DRIVER



PRODUCT FEATURES

- Constant Voltage LED Power Supply
- Moulded Polycarbonate Body
- Overload Protection
- Regulated Output
- Thermal Cutout
- SELV Rated

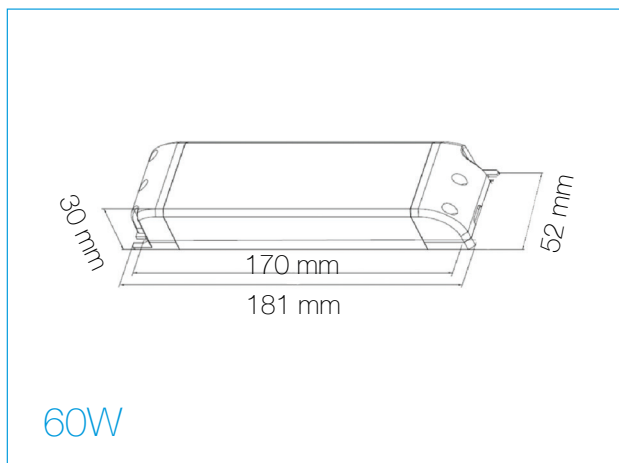

PRODUCT CODE	ADRCV2460
Operating Voltage	220-240 V AC
Output Voltage	24V DC
Output Wattage	0-60W
Output Current (Max.)	2.5A
Temperature	-15~+45°C