

## TECHNICAL DATASHEET

ASCRF/1G

1G Wireless LED Strip Dimming Wall Switch Fascia



### PRODUCT FEATURES

- Glass and Plastic Fascia
- 20m Range (Uninterrupted)
- Long Life Battery (Included)
- For Use with all ASCRF Range
- Fits in to Standard UK Backbox
- Can be Surface or Flush Mounted

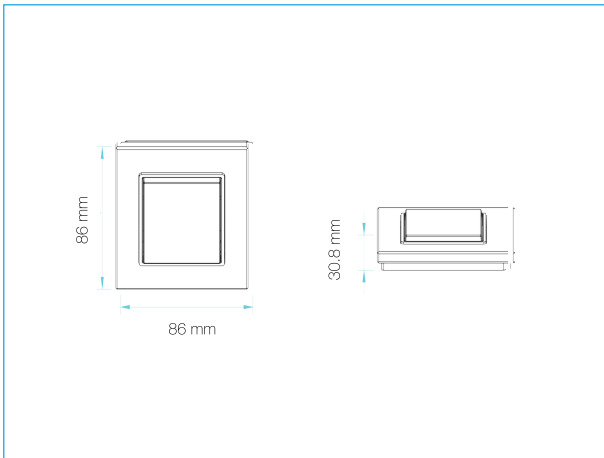

PRODUCT CODE	ASCRF/1G
Power Input Range	-
Battery Type	CR2430
Max Operating Distance	20M (Open Area)
Maximum Load (Output)	-
Signal Type	RF
IP	IP20
Operating Temperature	-10~+50°C