

Product Code: CU1AFDD32C

Luckinslive 433886053

Description: 1 Pole True 6kA C Curve 32A AFDD & RCBO 30mA

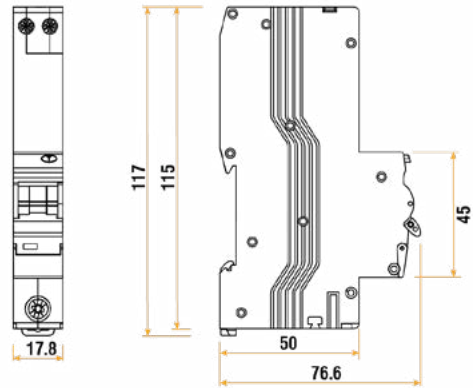

General Information

Dimensions (mm)	17.8 (W) x 118 (H) x 76.6 (D)
Colour	Light Grey
Rated Operational Voltage (AC) (Ue)	240
Frequency (Hz)	50/60
Maximum Rated Current (A) (In)	32
Rated Breaking Capacity (True kA) (Ics)	6
Impulse Withstand Voltage (Uimp)	4000
Endurance Mechanical Operations	6000
Endurance Electrical Operations	4000
Type	A
Trip Curve	C
Rated Making & Breaking Capacity (A) (Im)	500
Tripping Current (mA) (in)	30
Residual Non-Operating Current (IΔn)	0.03
Trip Type	Ground Fault: Electronic Over Current: Thermal/Magnetic
Device Terminals	Screwed Lug & Pin
Number Of Poles	1P + Switched Neutral
Input Terminal Capacity - Flexible (mm ²)	25
Input Terminal Capacity - Rigid (mm ²)	32
Input Terminal Torque (Nm)	2
Output Terminal Capacity - Flexible (mm ²)	16
Output Terminal Capacity - Rigid (mm ²)	25
Output Terminal Torque (Nm)	12
Circuit Protection	AFDD: Series Arc Fault, Parallel Arc Fault, Over Voltage Fault, Self-Test Fault, No fault RCBO: Earth fault, overcurrent & short-circuit
Neutral Tail Length (mm)	450
Ingress Protection	IP20
Operational Temperature (°C)	-25 to +40
Warranty (Years)	3

Standards BS EN 61009-1, BS EN 62606

Additional Information For cleaning / polishing of products, use only a soft, dry, clean cloth.
Recommended screwdriver: Input - PZ2, Output - PZ1

Condition	Repeats For 25 Seconds	After 25 Seconds
Series Arc Fault		See Fault Finding Guide
Parallel Arc Fault		
Over Voltage Fault		
Self-Test Fault		See Self-Test overview
No Fault		

