

14 Way Units

Board Product Code	CUEB14MS12	CUEB14MSRCD8	CUEB14MSRCDSP6	CUEHIB14MSRCD8
Ingress Protection	IP20			
IK Rating	IK05			
Operational Temperature	-5°C to +40°C			
Tail Clamp Capacity	25mm ²			
Tail Clamp Torque	1.2Nm Max			
CPC & N Bars Capacity	16mm ²			
CPC & N Bars Torque	2.0Nm			
Switch-Disconnecter Fitted	1 x 100A (CU2MS100)	1 x 100A (CU2MS100)	1 x 100A (CU2MS100)	1 x 100A (CU2MS100)
RCD Fitted	-	2 x 80A 30mA RCD (CU2RCD80A)	2 x 80A 30mA RCD (CU2RCD80A)	2 x 80A 30mA RCD (CU2RCD80A)
SPD Fitted	-	-	1 x 40kA SPD (CU2SPD275)	-
Free Ways	12	8 (4+4)	6 (3+3)	8
Nett Weight	4.3kg	5.2kg	5.4kg	5.2kg

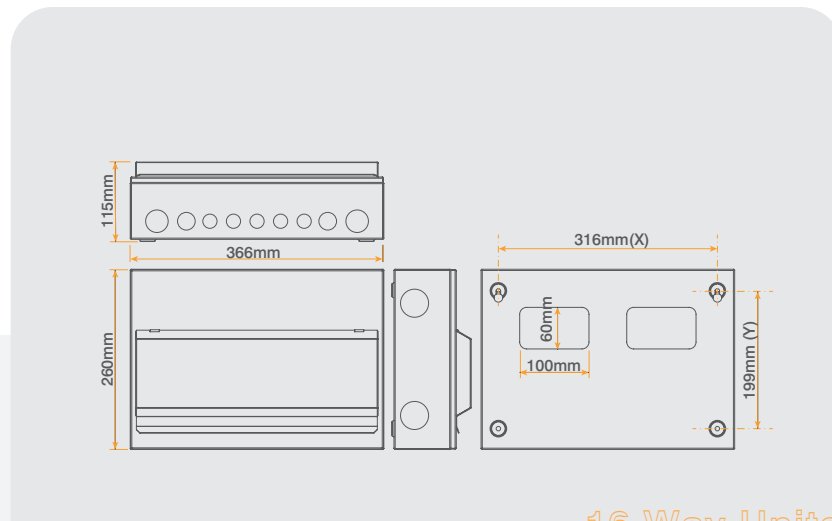

16 Way Units

Board Product Code	CUEB16MS14	CUEB16MSRCD10	CUEB16MSRCDSP8	CUEHIB16MSRCD10
Ingress Protection	IP20			
IK Rating	IK05			
Operational Temperature	-5°C to +40°C			
Tail Clamp Capacity	25mm ²			
Tail Clamp Torque	1.2Nm Max			
CPC & N Bars Capacity	16mm ²			
CPC & N Bars Torque	2.0Nm			
Switch-Disconnecter Fitted	1 x 100A (CU2MS100)	1 x 100A (CU2MS100)	1 x 100A (CU2MS100)	1 x 100A (CU2MS100)
RCD Fitted	-	2 x 80A 30mA RCD (CU2RCD80A)	2 x 80A 30mA RCD (CU2RCD80A)	2 x 80A 30mA RCD (CU2RCD80A)
SPD Fitted	-	-	1 x 40kA SPD (CU2SPD275)	-
Free Ways	14	10 (5+5)	8 (4+4)	10
Nett Weight	4.5kg	5.4kg	5.6kg	5.4kg